

An Introduction to a UML Platform Independent Model of a Software Radio

ICT'2002 Tutorial
Sunday, June 23rd, 2002

Michel Barbeau
Francis Bordeleau
Jeff Smith



ICT 2002

Objectives

- Introduce the concept of Software Radio
- Give a general overview of the Software Radio UML Model that is being standardized by the OMG
- Discuss issues related to the implementation of the UML model
- Promote Software Radios

ICT 2002

Outline

1. Introduction to Software Radio
2. Introduction to UML
3. Software Radio UML Model
4. Work in Progress

ICT 2002

-
1. Introduction to Software Radio
 2. Introduction to UML
 3. Software Radio UML Model
 4. Work in Progress

ICT 2002

Highlights of the wireless history

R. A. Fessenden, 1900

Radio-Telephone



M. Barbeau, 1962

Sending morse code



J. Mitola III, 1991

Software radio



G. Marconi, 1895
wireless telegraphy



H. Lamarr and G. Antheil,
1942
frequency-switching



R. Barbeau, 1962
Fixing a FM radio

ICT 2002

What is Digital Signal Processing?

- Measuring analog signals
- Recording measurements as series of numbers
- Processing the numbers
- Converting back to analog signals

ICT 2002

What is a Software Radio?

- Radio with functions implemented in software
- Multi-band antennas
- Transmitter
 - conversion of digital to analog (DAC), possibly to an IF and then to RF
- Receiver
 - wideband analog to digital conversion (ADC), down conversion, demodulation
- Increasing flexibility via increased programmability
- Require a multi-disciplinary approach

ICT 2002

A Simple Software Radio Architecture

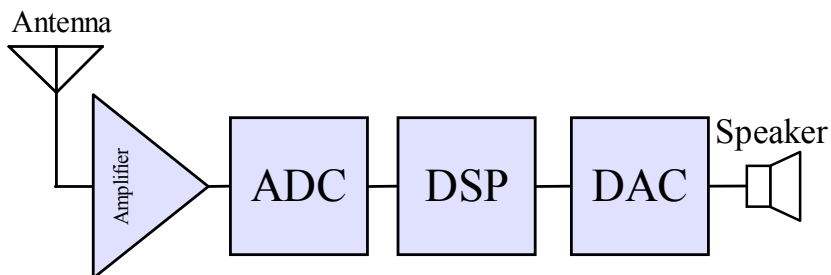

ICT 2002

Half-complex mixer

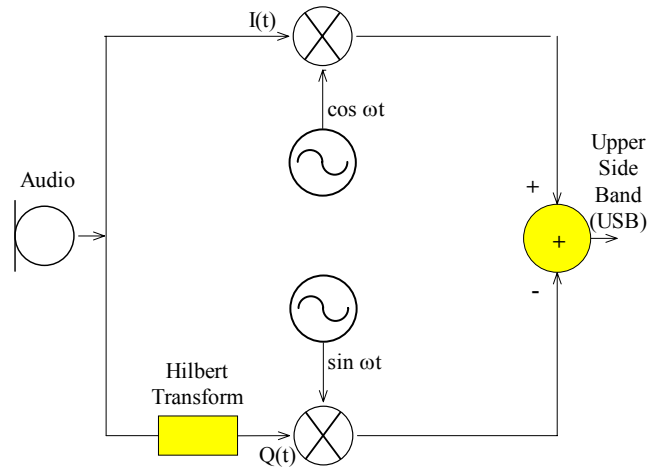

ICT 2002

Waveforms

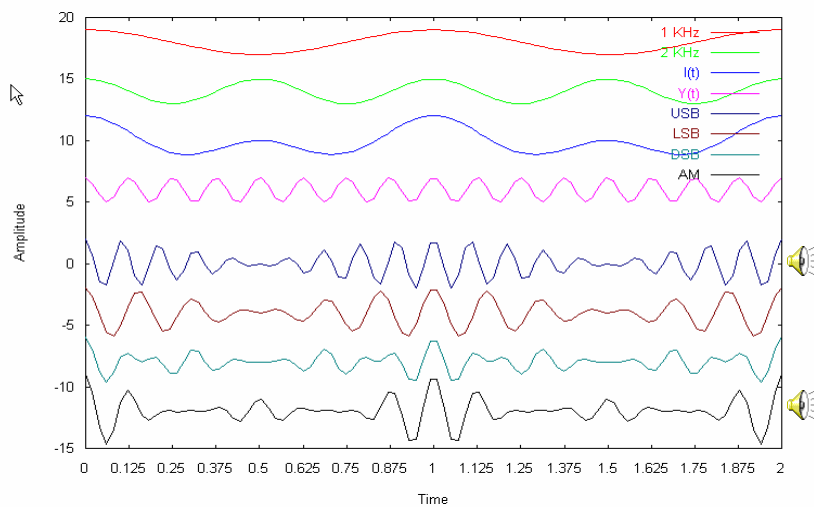

ICT 2002

Single Side Band (SSB) Generation

Method: phasing method

$I(t)$, Amplitude of an audio signal versus time (real signal with a two-sided spectrum)

Quadrature signal $Q(t)$

All frequency-components of $I(t)$ phase shifted by 90° (Hilbert transform)

Analytic signal

Complex signal with only positive-frequency components

$$I(t) + jQ(t)$$

Carrier: Complex oscillator

$$Y(t) = \cos \omega_0 t + j \sin \omega_0 t$$

Upper Side Band (USB) signal: Product of analytic signal with complex oscillator

$$Y(t)[I(t) + jQ(t)] = I(t) \cos \omega_0 t - Q(t) \sin \omega_0 t \quad \text{Only real part is computed}$$

ICT 2002

What is a Software Defined Radio?

“Software-defined radios let service providers reprogram base stations to reassign channels as standards change and the mix of analog vs. digital users shifts. And engineers envision handsets that someday will download from any network whatever code is needed to reprogram themselves to access a wireless service or run a mobile application.” EE Times November 15, 2000.

ICT 2002

Application Domains

- Military and Commercial
 - Air traffic control
 - Cellular phone
 - Computer networks
 - Pervasive computing
 - Satellite telecommunications

ICT 2002

Software Defined Radio Architecture

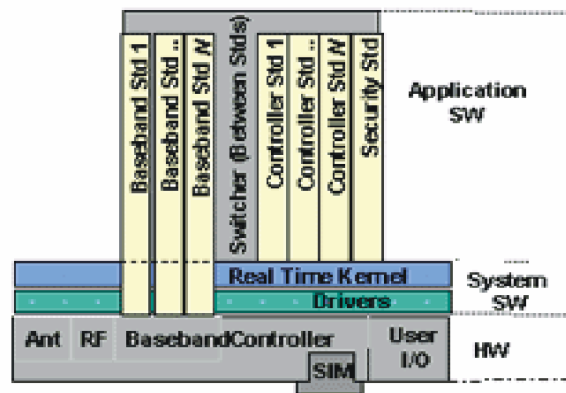

Handheld Multiple Service Model Using SDR

ICT 2002

Current Standardization Efforts

- Software Communications Architecture (SCA)
 - Published by Joint Tactical Radio System (JTRS) Joint Program Office (JPO)
 - Developed by the Modular Software-programmable Radio Consortium (MSRC), which is composed of Raytheon, Harris, BAE, and ITT
- SDR Forum
 - More than 138 members including Boeing, CRC, France Telecom, Harris, Mercury Computer Systems, Motorola, Nortel Networks, Raytheon Systems, Spectrum, Thales, etc.
- OMG SWRadio DSIG
 - Develop the Platform Independent Model (PIM) and some Platform Specific Models (PSMs)
 - Led by Mitre, Mercury Computer Systems, and Raytheon
 - Main contributors includes MSRC members, Mercury Computer Systems and Carleton University

ICT 2002

Software Reference Model (SCA)

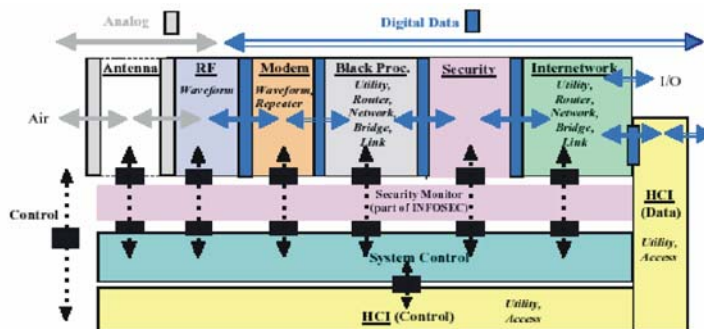

ICT 2002

Current Radio Issues

- There is a large inventory of waveforms and communication services. This is especially true for the Armed Forces and is also a growing concern for the commercial waveform migration.
- Waveform and Service Applications are typically not portable across hardware platforms.
- Interoperability is limited based upon radios' reprogrammability.
- Many current radios are not re-programmable; they must be replaced when new capabilities are desired.
- Radios from different manufactures implementing the same waveform cannot inter-operate with each other.
- Command and Control is different for each Radio.
- General software solutions to these issues tend to increase radio size, weight and power, especially critical to mobile radios.

ICT 2002

Scope of Proposals Sought by OMG

The scope of the RFP is to provide software radio infrastructures to:

- Yield interoperable waveforms and radios
- Yield programmable and re-programmable radios by defining APIs within the radio that waveforms are built upon
- Promote waveform software portability and reuse across hardware platforms
- Be open and documented to allow 3rd party waveform development
- Maximize independence of waveform from specific hardware solutions

ICT 2002

Scope of Proposals Sought by OMG (cont'd)

- Be extendible to new waveforms and/or hardware components
- Providing a standard Application Program Interface (API) for code portability with different OSs.
- Updating instead of replacement when new capabilities desired.
- Storage provisions for a library to contain the waveform inventory.
- Be scalable from low-capability (mobile phones) to high-capability radios (e.g., basestations, multi-channel radios, etc.).
- Provide for rapid technology insertion for new hardware and software technologies as they become available over time

ICT 2002

1. Introduction to Software Radio
- 2. Introduction to UML
3. Software Radio UML Model
4. Work in Progress

ICT 2002

Unified Modeling Language



• Graphical Language for $\left\{ \begin{array}{l} \text{Visualizing} \\ \text{Specifying} \\ \text{Constructing} \\ \text{Documenting} \end{array} \right\}$ the artifacts of Software-based systems

- Standard for object oriented software modeling
- Allows modeling different aspects (different views)
- Allows modeling systems at different levels of abstraction
- Scenario driven process

ICT 2002

Different Views

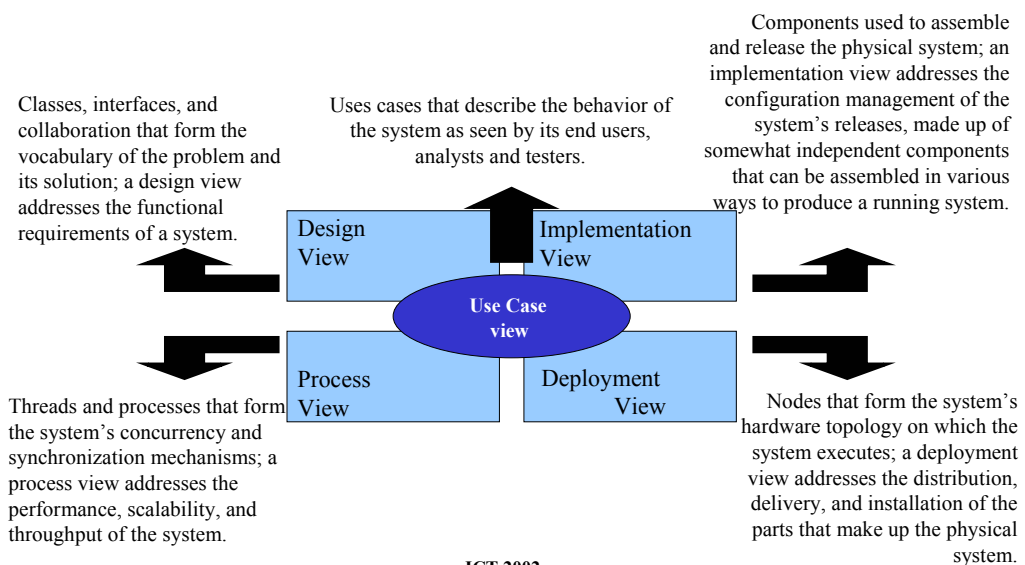

ICT 2002

Different Diagrams

Use Case

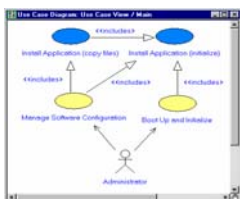

Use Case Description



Sequence

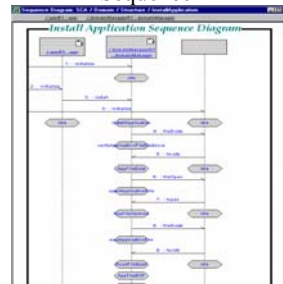

Class

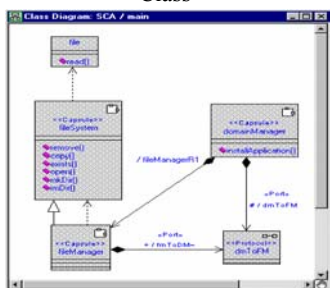

Capsule structure

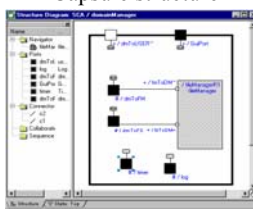

Statecharts

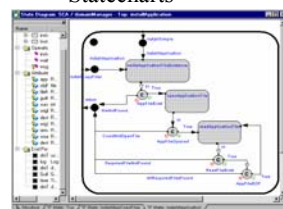

From Design to Implementation

How do we build software today?



Traditional

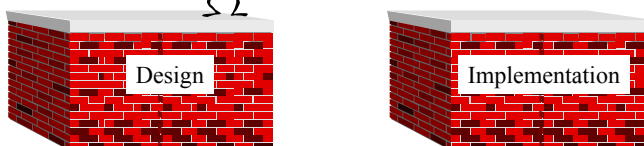

UML-RT

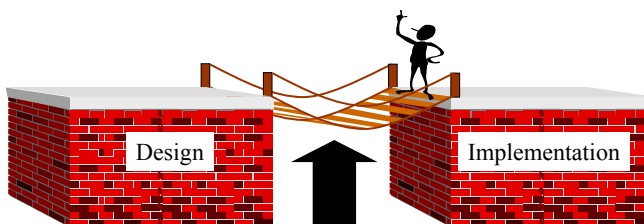

Code Generation

Model Driven Architecture

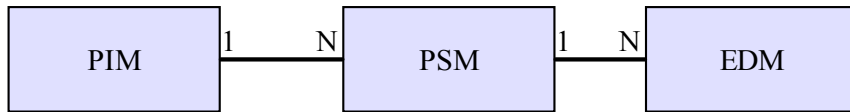

ICT 2002

Model Driven Development

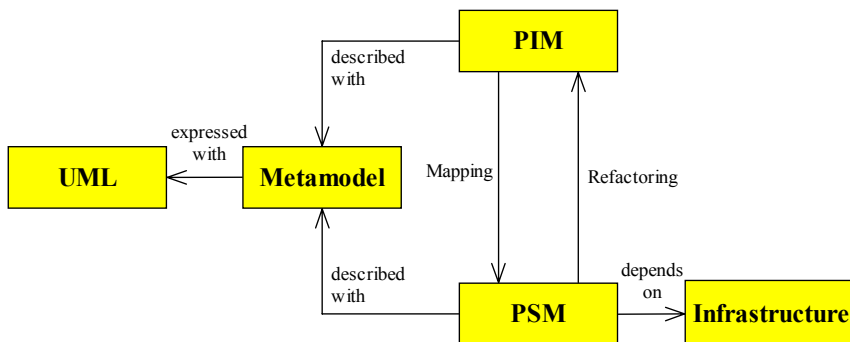

ICT 2002

1. Introduction to Software Radio
2. Introduction to UML
- 3. Software Radio UML Model
4. Work in Progress

ICT 2002

Key Concept: Waveform

- Transformations
- In a SWR transmitter, encode information and produce a signal that can be transmitted over the air
- In a SWR receiver, decode a signal received over the air and produce information

ICT 2002

Key Concept: Application

- Is a program that realizes a given waveform
- Provides an interface through which it can configured, controlled and monitored.

ICT 2002

Key Concept: Domain

- Is a set of hardware devices and applications
- A given domain is under the control of a domain manager

ICT 2002

SWR PIM Dependencies

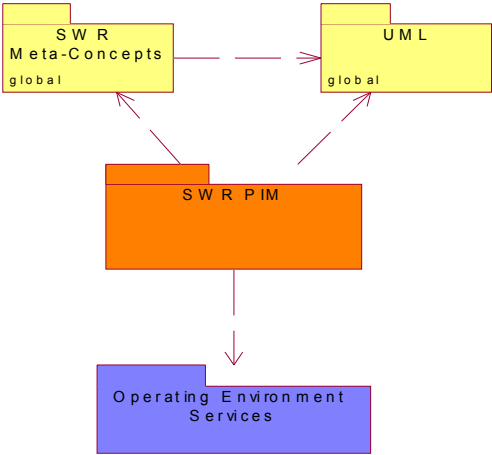

ICT 2002

SWR PIM Package

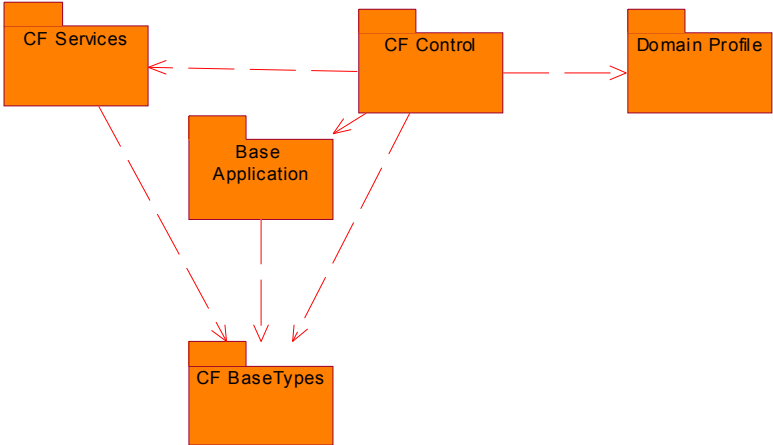

ICT 2002

Base Application Package

- The Base Application package defines the elements that are at the core of an application

ICT 2002

Base Application Package

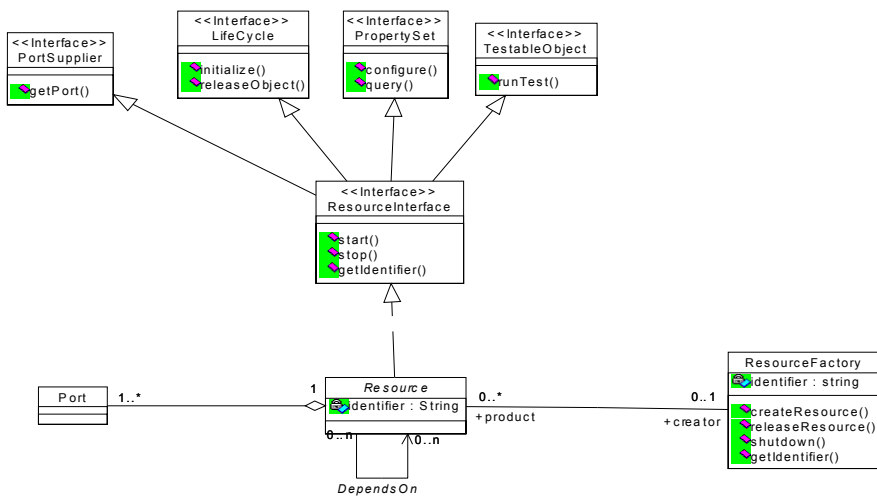

ICT 2002

CF Control Package: Domain Manager

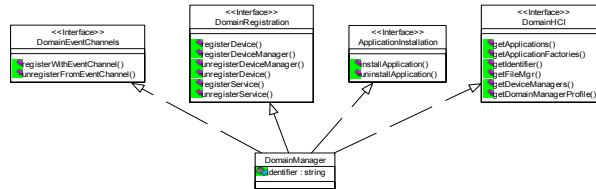

ICT 2002

CF Control Package: Domain Manager

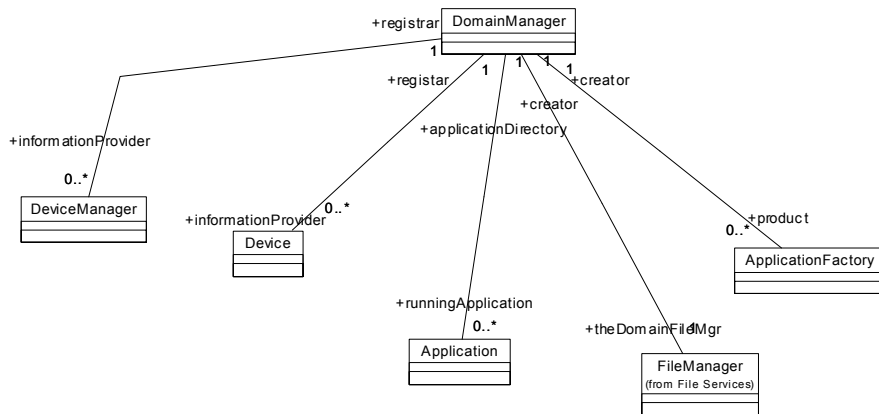

ICT 2002

Device Types

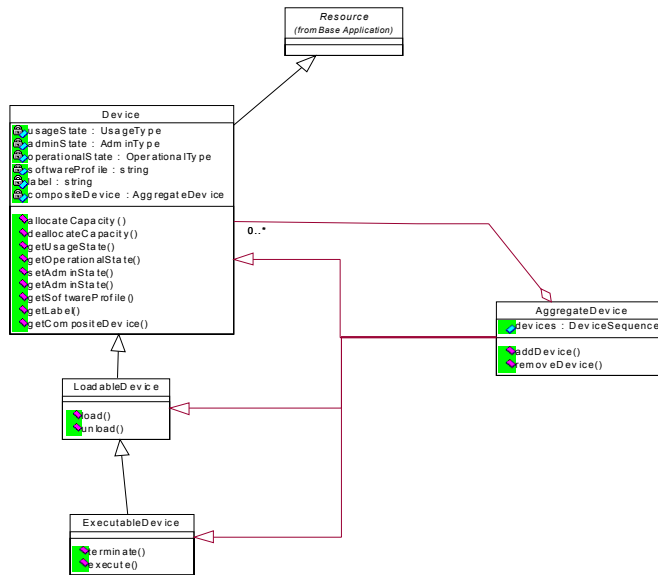

ICT 2002

CF Services Package

- Event Services
- Logging Services
- File Services
- Naming Services

ICT 2002

Event Services

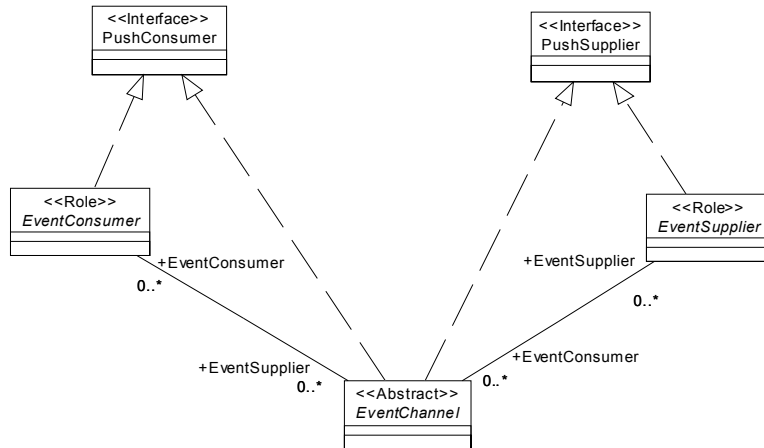

ICT 2002

Event Services

The **EventChannel** represents an abstract concept that can be implemented using different mechanisms. One example is the **OMG Event Service** implementation, which connects "Proxy" suppliers to consumers and vice versa. However, it is not necessary to implement the **EventChannels** in the same way, as long as the following requirements are adhered to:

Requirements:

- **EventChannels** exist if and only if they are named in the Domain Profile (except for the **IncomingDomainEventChannel** and the **OutgoingDomainEventChannel**, which always exist)
- Must implement **Asynchronous communication**
- **Decouples EventSupplier and EventConsumer**
- Implements the **PushConsumer** Interface to communicate with **EventSuppliers**
- Implements the **PushSupplier** Interface to communicate with **EventConsumers**

ICT 2002

Logging Services

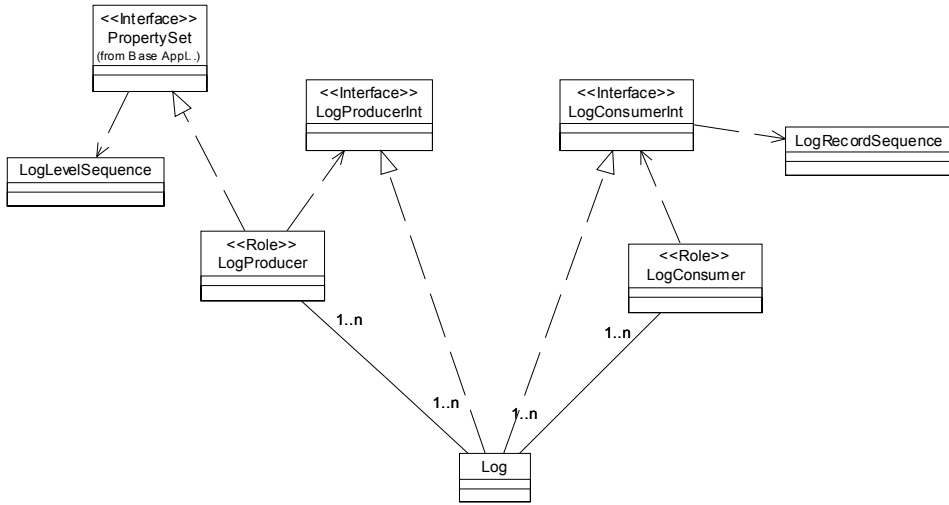

ICT 2002

Logging Services: Log Relationships

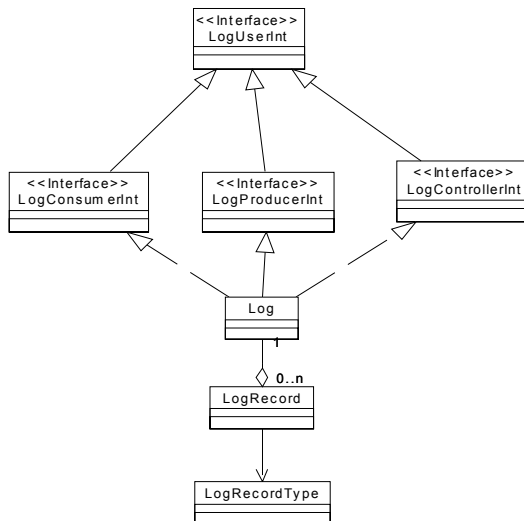

ICT 2002

Logging Services

A Lightweight Logging Service is being proposed as an OMG RFC. The OMG Software Radio Special Interest Group is the focal point of this activity. However, the particular characteristics of the proposed Lightweight Logging Service open up a much wider field of application, particularly in the area of embedded and/or real-time systems.

Key characteristics, which distinguish this service also from the OMG Telecom Log Service, are:

- No dependency on other services. The Lightweight Logging Service is a stand-alone service.
- Aim for a minimum footprint. The Lightweight Logging Service contains just a basic time-based logging facility. No expensive components like filters, federation, or event forwarding are contained to keep the size of an implementation to a minimum.
- The logging system specified by the Lightweight Logging Service is totally decoupled from potential log producer clients. Emitting log records to the logging facility has no side-effects on the operation or the timing of the log producer.

ICT 2002

File Services

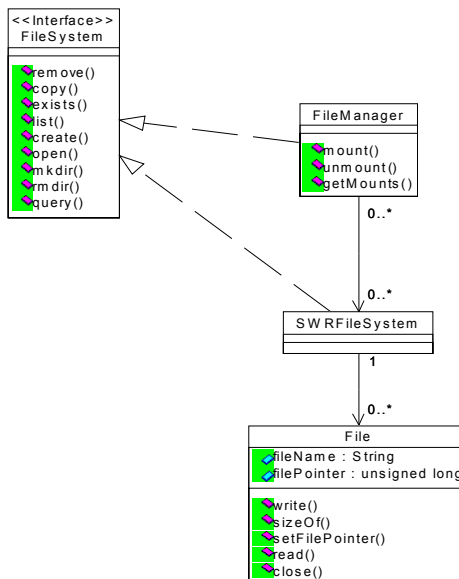

The file service classes (FileManager, FileSystem, and File) are used for installation and removal of application files within the system, and for loading and unloading application files on the various processors that the Devices execute upon.

ICT 2002

Naming Services

- A Naming Service shall be provided in the OE (e.g. a CORBA Naming Service). The Naming Service supplied by an OE shall support the following operations: bind, bind_new_context, unbind, destroy, and resolve. These operations shall meet the requirements of OMG Document formal/00-11/01: Interoperable Naming Service Specification. An example of such naming service is the CosNaming CORBA module and its NamingContext interface's operations.
- A Naming Service's NameComponent structure is made up of an id-and-kind pair. The "id" element of each NameComponent is a string value that uniquely identifies a NameComponent. The "kind" element of each NameComponent shall be "" (null string).

ICT 2002

Domain Profile Package

The hardware devices and software components that make up an SCA system domain are described by a set of files that are collectively referred to as a Domain Profile. These files describe the identity, capabilities, properties, inter-dependencies, and location of the hardware devices and software components that make up the system. All of the descriptive data about a system is expressed in the XML vocabulary. For purposes of this SCA specification, the elements of the XML vocabulary have been based upon the OMG's CORBA Components specification (orbos/99-07-01). [Note: At the time of this writing, 99-07-01 is a draft standard].

ICT 2002

Domain Profile Package

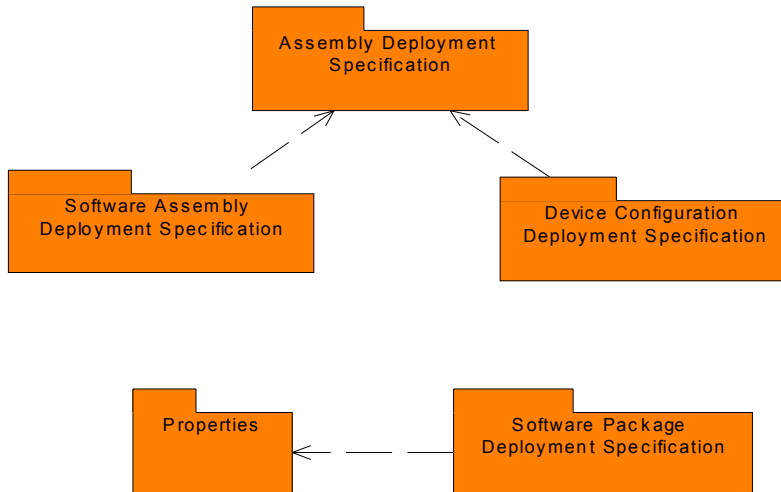

ICT 2002

CF Base Types Package

- A utility package that defines data types used by other elements of the UML model of the SWR

ICT 2002

CF Base Types Package

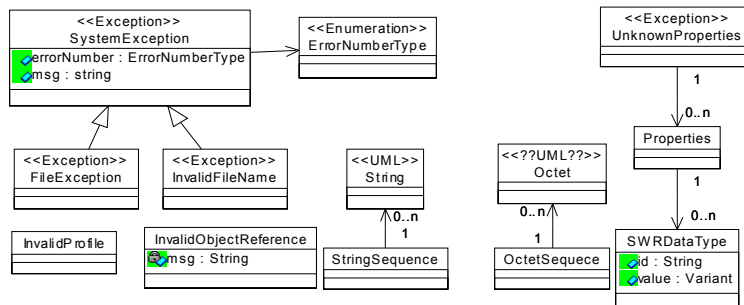

ICT 2002

1. Introduction to Software Radio
2. Introduction to UML
3. Software Radio UML Model
- ➔ 4. Work in Progress

ICT 2002

Current Projects/Collaborations

- Simulator for the SCA specification (Mercury Computer Systems, CRC , CITO)
- SDR Metamodel (Mercury Computer Systems, Mitre, Raytheon)
- Platform Independent Model (PIM) (Mercury Computer Systems and CRC)
- SCA Validation Framework (Mercury Computer Systems)